

PILATUS PC-24

The world's only
Super Versatile Jet

Jetfly

FASTER, CLOSER

Introducing the PC-24, the only aircraft combining the versatility of a turboprop with the cabin of a medium sized jet and with light jet performance.

It is a plane that simply doesn't fit into any of the existing business jet categories, that's why Pilatus had to create a new one: The Super Versatile Jet category.

Jetfly is proud to present the world's first and only Super Versatile Jet: The Pilatus PC-24.



PILATUS PC-24

VERSATILITY of the PC-12	SPEED, RANGE & CABIN of a Medium Sized Jet	PRICE of a Light Jet
-----------------------------	---	-------------------------



- Zone 1
- Zone 2
- Out of zone
- Restricted

2 PILOTS
4 PAX
1.500 NM / 2.800 KM
03H40

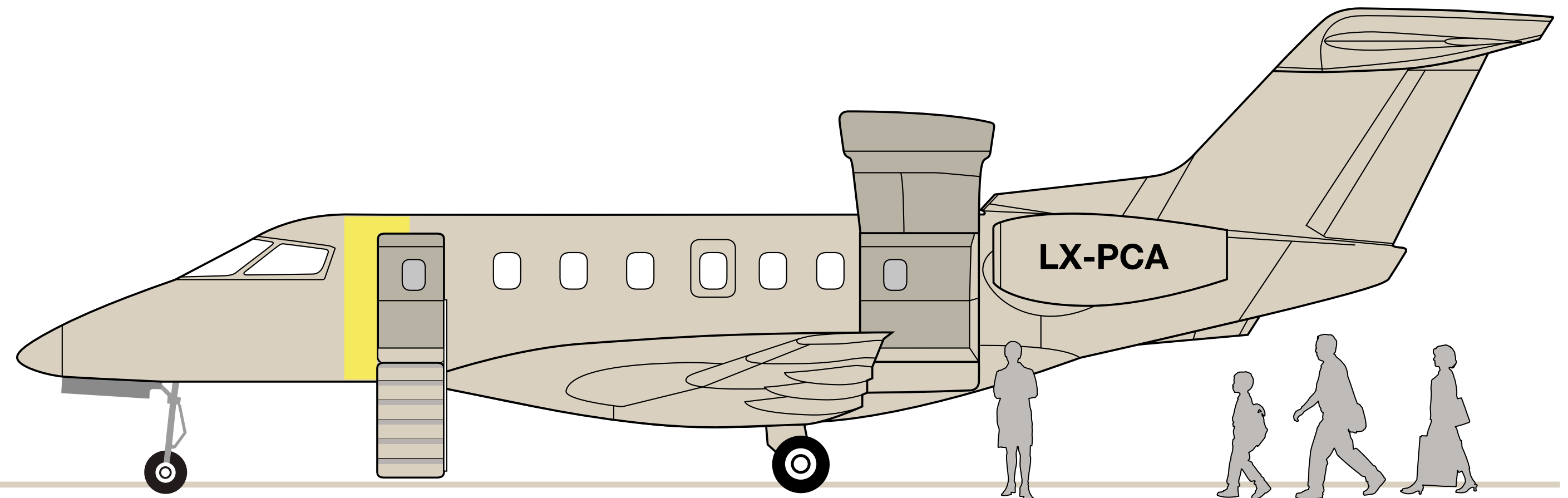
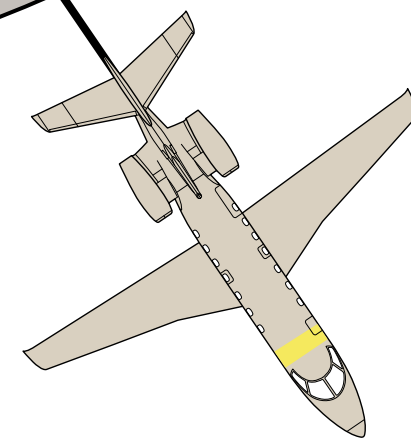

CABIN
14,2 METERS³

SEATS
8

SPEED
440 KNOTS / 815 KM/H

RANGE MAX (2 pilots/1 pax)
1.800 NM / 3.300 KM

LANDING
850 METERS



THE PC-24 CABIN

The cabin is superior to other business jets which cost almost twice as much. It has 8 passenger seats in a double club cabin configuration..

A LARGE CARGO DOOR

Thanks to the rear "Cargo" door measuring 1.30 m x 1.25 m, bulky luggage such as golf bags, skis and bicycles can be taken on board.



Grass runway, Epernay aerodrome.

JETFLY PROGRAM ADVANTAGES

- 1 Availability of your aircraft is guaranteed
- 2 Invoiced based on occupied hours only
- 3 Access to 3 000+ airports and small airfields
- 4 No cancellation fees



Double club cabin configuration

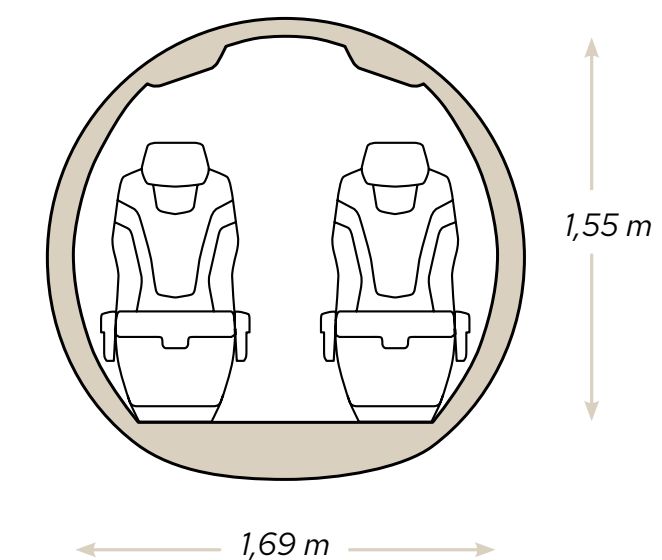

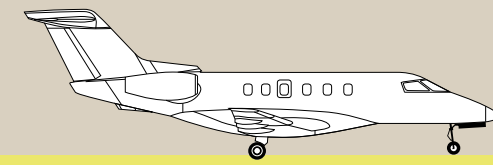

AUGUST 2014
Roll out

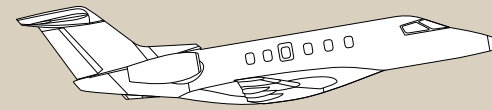

MARCH 2015
First flight

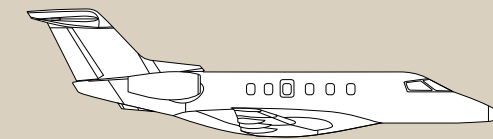

DECEMBER 2017
Certification

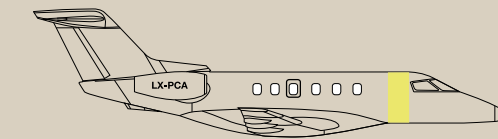

SEPTEMBER 2018
First delivery to Jetfly

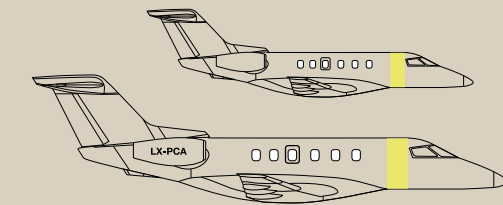

JUNE 2022
Fleet of 12 PC-24

Jetfly

+352 26 19 36 36
info@jetfly.com
www.jetfly.com

11, rue Jean Fischbach
L-3372 Leudelange
Luxembourg